

- DE Füllautomat**
- FR Collecteur Filtrant Eco**
- EN Filling Device with overflow stop**
- ES Filtro de bajante Eco**
- IT Sistema di riempimento automatico con blocco per troppopieno**

Montageanleitung
 Notice d'installation
 Installation Instruction
 Instrucciones para montaje
 Introduzione d'installazione

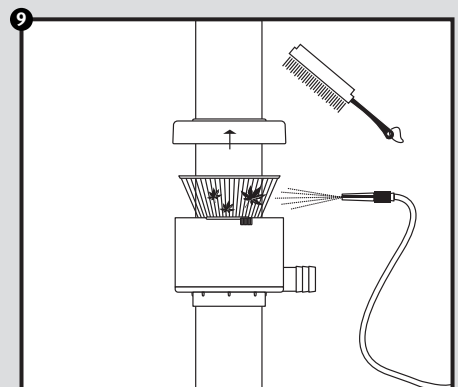
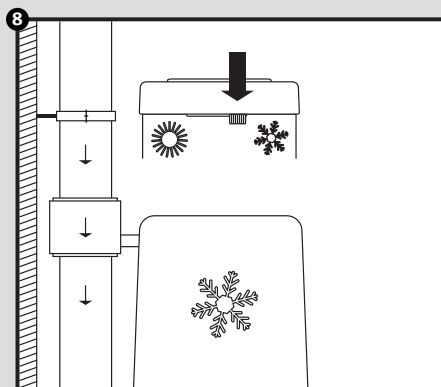
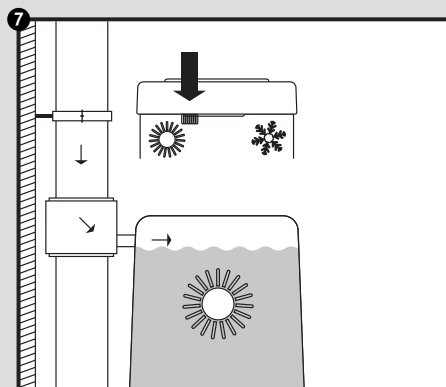
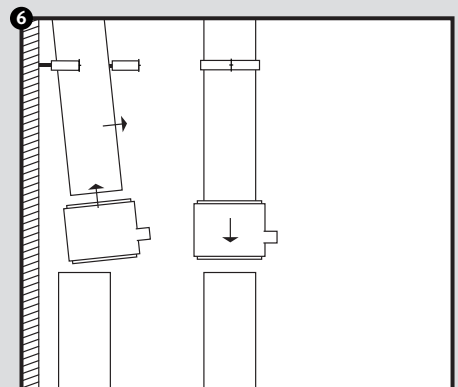
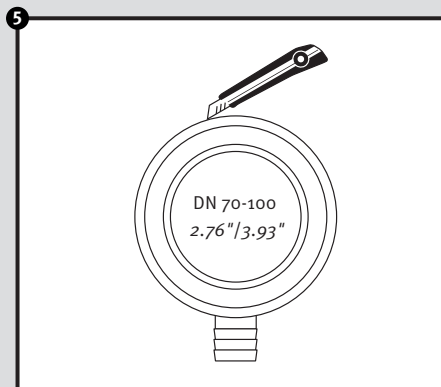
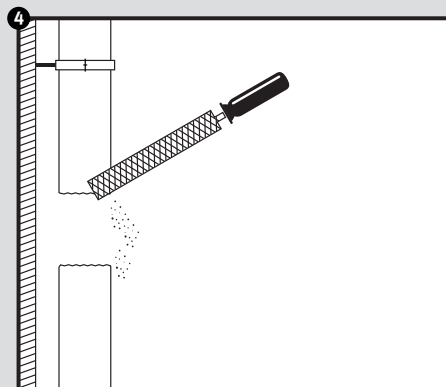
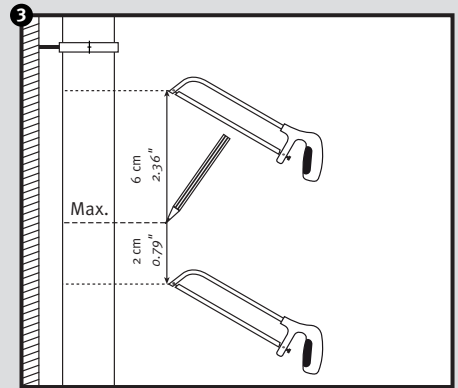
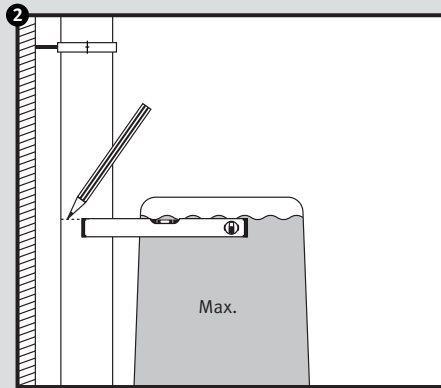
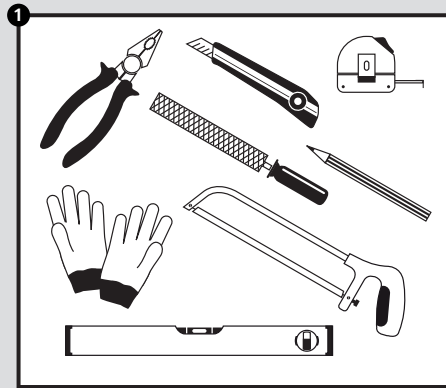
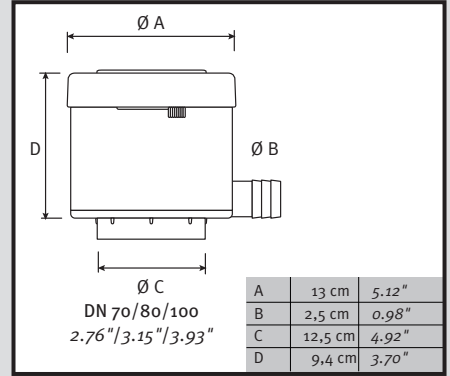
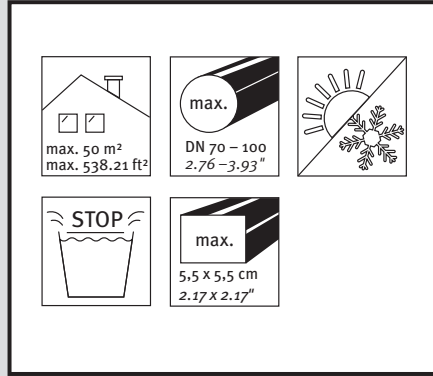
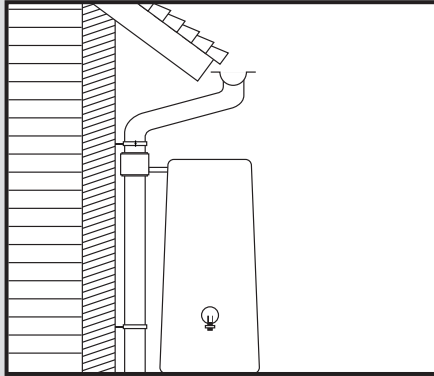

N° 503010 N° 503011 N° 503020 N° 503021 N° 503022

23.05.2014